

# GREYSTONE

## ENERGY SYSTEMS INC

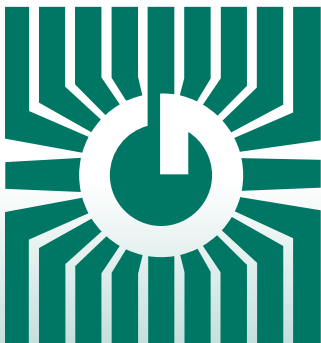

### CARBON MONOXIDE (CO) DETECTORS CMD Series



### Precision gas control/sensing

#### FEATURES:

- Space or duct mount models
- Long-life electrochemical sensor
- Various analog outputs
- LCD display
- Optional relay outputs & audible alarm
- BACnet or Modbus communication

*Peace of mind  
through reliable  
gas monitoring*

GREYSTONE HAS AN ISO 9001 REGISTERED QUALITY SYSTEM

## DESCRIPTION:

The CMD5B1 Series carbon monoxide detector uses a superior electrochemical sensor for reliability and accuracy in even the most critical applications. The standard product features a 2-wire loop-powered output. Optionally, the device may be configured with an alarm relay which operates in 3-wire sourcing mode and/or with Modbus communications.

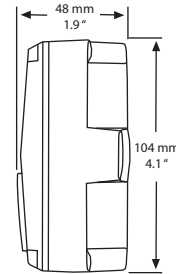
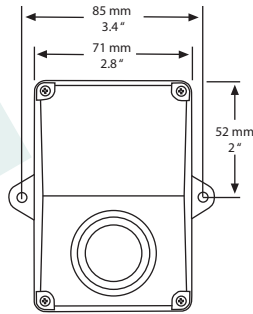

## SPECIFICATION:

Sensor Type .....	Electrochemical
Sensor Agency Approvals .....	Sensor is a UL Recognized Component for ANSI/UL-2034, UL-2075, E240671
Measurement Range .....	<b>Analog:</b> 0-300 PPM <b>Modbus:</b> 0-500 PPM
Accuracy .....	±5 PPM or 5% of reading for 0-300 PPM (whichever is greater)
Accuracy rated .....	0° to 50°C (32° to 122°F), 15 to 95%
Life Expectancy .....	5-7 years in air
Typical Coverage Area .....	700 m <sup>2</sup> (7500 ft <sup>2</sup> ) or 15m (50ft) radius
Operating Conditions .....	-20° to 50°C (-4° to 122°F), 15 to 95% RH
Sample Method .....	Diffusion
Stability .....	<5% signal loss/year
Response Time .....	<35 seconds for 90% step change
Power Supply .....	24 Vdc ±20% or 24 Vac ±10% (non-isolated half-wave rectified) <b>Modbus:</b> 24 Vdc ±20%
Consumption .....	20 mA max. <b>with Relay option:</b> 50 mA max. <b>Modbus:</b> 35 mA max.
Input Voltage Effect .....	Negligible over specified operating range
Protection Circuitry .....	Reverse voltage protected and output limited
Output Signal .....	4-20 mA loop-powered, 4-20 mA sourcing with relay option
Output Drive at Capability .....	550 ohms max. @ 24 Vac/Vdc
Optional Relay Output .....	Form C contact (N.O. and N.C.) - <b>Not available with Modbus Communications</b>
.....	5 amps @ 250 Vac, 5 amps @ 30 Vdc, p.f. = 1
.....	Trip Point - 25, 60 or 150 PPM, jumper selectable
.....	Hysteresis - 3% or 9 ppm
Optional Modbus .....	Hardware..... 2-wire RS-485
.....	Software..... Native ModBus MS/TP protocol (RTU)
.....	Baud Rate..... 9600
.....	Slave Address Range..... Locally set to 1-255
.....	Parity..... None
.....	Stop Bits..... 1
.....	CRC..... A001 (CRC-16 reverse)
Wiring Connections.....	Screw terminal block (14 to 22 AWG)
External Dimensions .....	71 x 104 x 48 mm (2.8" w x 4.1" h x 1.9"d)
Enclosure Ratings .....	ABS - UL94-V - IP65, (NEMA 4X)
Field Calibration .....	By applying calibration gas standards (Contact Greystone for calibration kit)
Accessories .....	Calibration kit, model# CMD-CALKIT-GS

## PRODUCT ORDERING INFORMATION:

MODEL	Description
CMD5B1	Carbon Monoxide Detector (CO), Electrochemical, Loop-powered

CODE	Relay
000	No Relay
100	Relay ( <b>Not available with Modbus Communications</b> )

CODE	Options
MOD	Modbus Communications

CMD5B1	100	-	← Typical Model Number
--------	-----	---	------------------------

Greystone Energy Systems Inc. reserves the right to make design modifications without prior notice.

## DESCRIPTION:

The CMD5B4 & 5 Series carbon monoxide detector uses an electrochemical sensor to monitor the carbon monoxide level and outputs a field-selectable 4-20 mA or voltage signal. The voltage signal may be set to 0-5 or 0-10 Vdc. The sensing range and output may be scaled to either 100, 150, 300, 400 or 500 ppm via the on-board menu. A front panel LCD is standard to ensure easy setup and operation. It is available in either wall/surface or duct mount configurations.

Other standard features include a back light for the LCD, a front panel test switch, status indication and an alarm buzzer. The test function may also be controlled remotely with a digital input signal. The on-board menu allows local configuration of all device parameters.

Optional features include one or two alarm relays and/or RS-485 network communication configured for either ModBus or BACnet protocol.

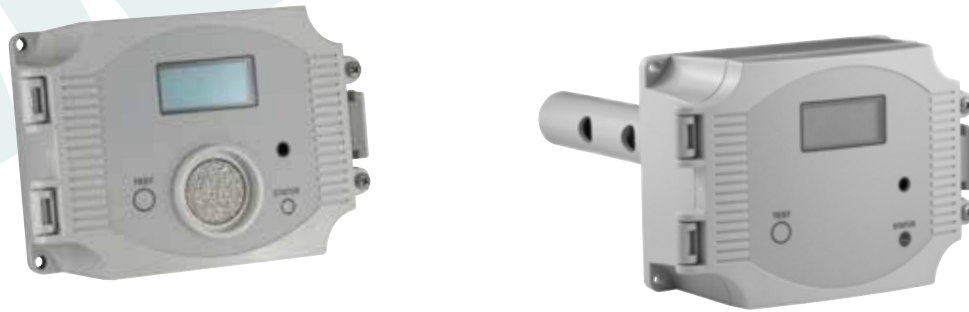

## SPECIFICATION:

Sensor Type .....	Electrochemical
Sensor Agency Approvals .....	Sensor is UL Recognized Component for ANSI/UL-2034, UL-2075, E240671
Measurement Range.....	0-100, 150, 300, 400, or 500 PPM (Selectable)
Accuracy .....	±5 PPM or 5% of reading (whichever is greater)
Accuracy rated.....	0° to 50°C (32° to 122°F), 15 to 95%
Life Expectancy .....	5-7 years in air
Typical Coverage Area .....	700 m <sup>2</sup> (7500 ft <sup>2</sup> ) or 15 m (50 ft) radius
Operating Conditions .....	-20° to 50°C (-4° to 122°F), 15 to 95% RH, 0.9 to 1.1 atm
Sample Method .....	Diffusion or flow through sample tube for duct mounted models
Stability .....	<5% signal loss/year
Response Time .....	<35 seconds for 90% step change
Power Supply.....	24 Vdc ± 20% or 24 Vac ± 10% (non-isolated half-wave rectified)
Consumption .....	100 mA max. with all options on
Protection Circuitry.....	Reverse voltage protected and output limited
Output Signal.....	4-20 mA active (Active), 0-5 or 0-10 Vdc (Selectable)
Output Drive at Capability .....	450 ohms max for current output, 10 Kohms min for voltage output
Output Resolution .....	10 bit PWM (±0.4 ppm)
LCD Display.....	Displays PPM and menu parameters 1 PPM resolution, 35 mmW x 15 mm H (1.4" x 0.6") Alpha-numeric 2 line X 8 character with backlight
Status LED .....	Two color (red/green) on front panel
Test Switch .....	Performs I/O tests, front panel and remote connection
Buzzer Alarm .....	85 db @ 10 feet
Buzzer trip Point .....	Programmable 20-500 ppm in 10 ppm increments
Buzzer Delay.....	Programmable 0-10 minutes in 1 minute increments
Optional Relay Output .....	One or two Form C contact (N.O. and N.C.) 5 amps @ 250 Vac, 5 amps @ 30 Vdc, p.f. = 1 Relay 1 Trip Point - Programmable 20-500 PPM in 10 PPM increments Relay 2 Trip Point - Programmable 20-500 PPM in 10 PPM increments Relay Hysteresis - Programmable 10-100 PPM in 5 PPM increments Relay Delay - Programmable 0-10 minutes in 1 minute increments
Optional Communications .....	BACNet or Modbus (Refer to installation instructions for full details)
Wiring Connections.....	Screw terminal block (14 to 22 AWG)
External Dimensions .....	Space, 145 x 101 x 64mm (5.7" w x 4" h x 2.5" d) Duct, 145 x 101 x 240mm, (5.7" w x 4" h x 9.5" d) includes probe
Enclosure Ratings.....	Space (4) - ABS - UL94-V - IP65, NEMA 4X Duct (5) - ABS - UL94-V - IP65, NEMA 4X
Field Calibration.....	By applying calibration gas standards (Contact Greystone for calibration kit)
Accessories .....	Calibration kit, model# CMD-CALKIT-GS

## PRODUCT ORDERING INFORMATION:

MODEL	Description
CMD5B	Carbon Monoxide Detector (CO), Electrochemical

CODE	Enclosure
4	Space Gray ABS
5	Duct Gray ABS

CODE	Relay (s)
000	No Relay
100	One Relay
110	Two Relays

CODE	Options
BAC	BACNet Communications
MOD	Modbus Communications

CMD5B	4	00	-	← Typical Model Number
-------	---	----	---	------------------------

Greystone Energy Systems Inc. reserves the right to make design modifications without prior notice.

## DIMENSIONS:

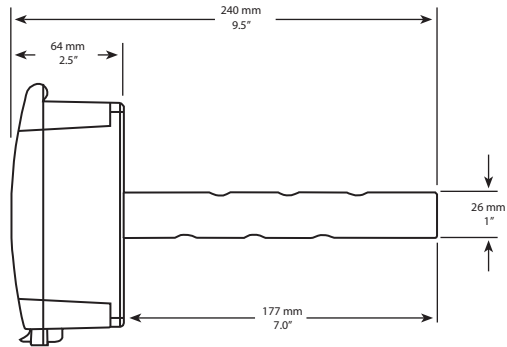
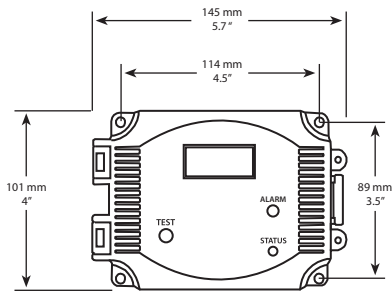
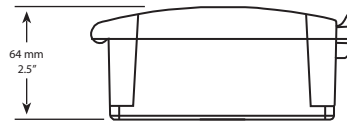
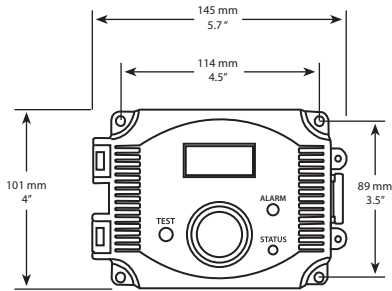

**GREYSTONE**  
ENERGY SYSTEMS INC

Greystone Energy Systems Inc.  
150 English Drive, Moncton,  
New Brunswick, Canada E1E 4G7

(506) 853-3057 Fax: (506) 853-6014  
North America: 1-800-561-5611  
e-mail: mail@greystoneenergy.com  
web site: www.greystoneenergy.com

RoHS  
COMPLIANT



*Greystone Energy Systems Inc. is one of North America's largest ISO registered manufacturers of HVAC/R sensors and transmitters for Building Automation Management Systems.*

*We have conscientiously established a worldwide reputation as an industry leader by maintaining leading-edge design technology, prompt technical support, and a commitment to on-time deliveries. We take pride in our Quality Management System which is ISO 9001 certified, assuring our customers of consistent product reliability.*

GREYSTONE HAS AN **ISO 9001** REGISTERED QUALITY SYSTEM